

MyPlan 300 Mirror Unit For Downlighters Assembly Instructions

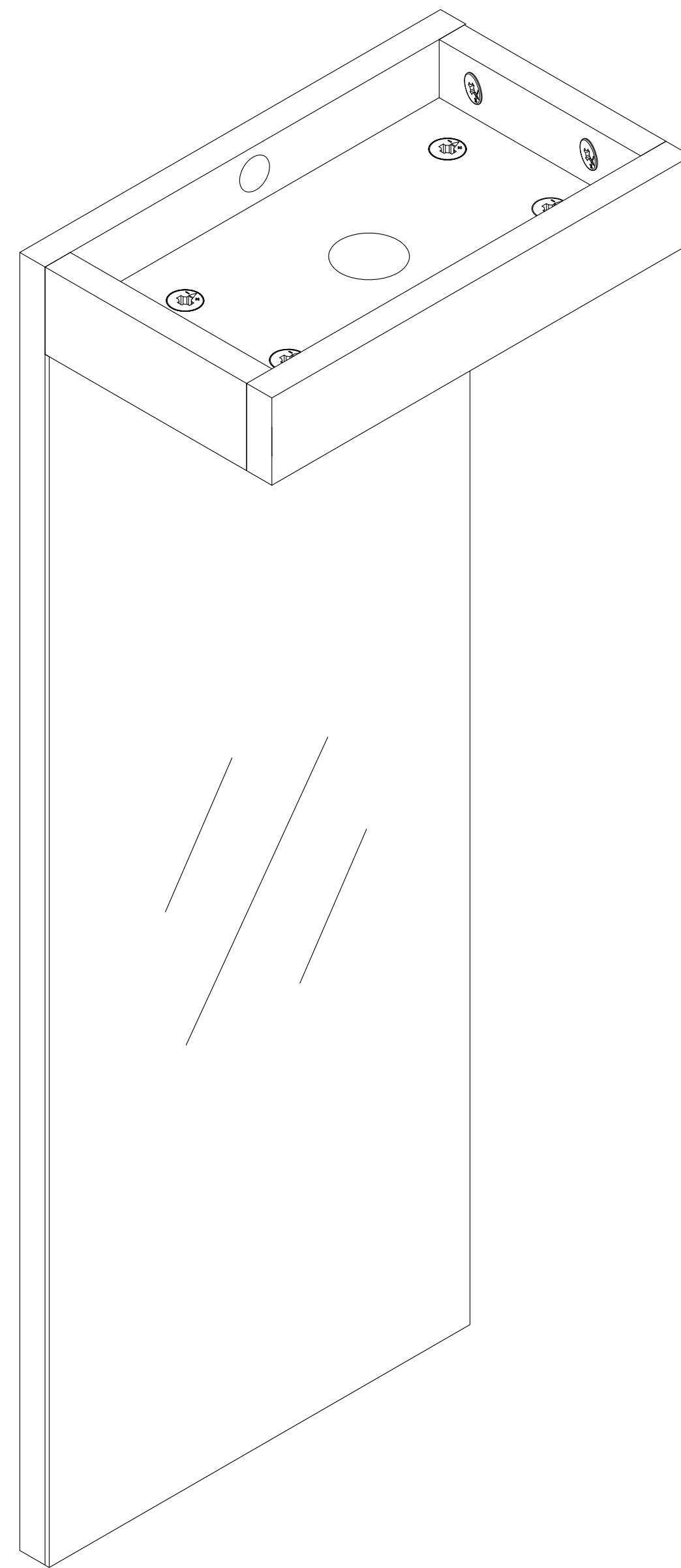



41405010890
41405011130
41405011370

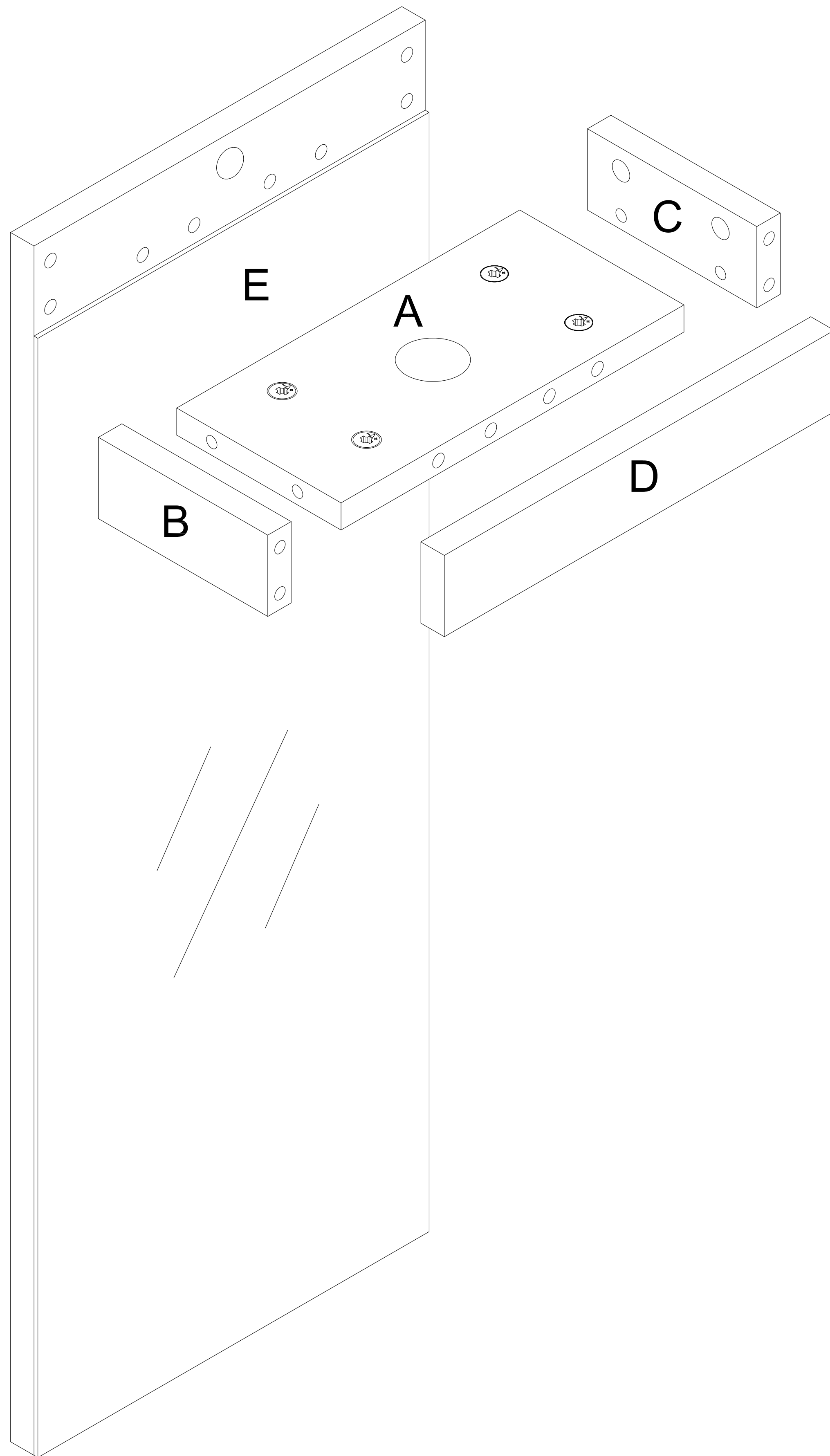
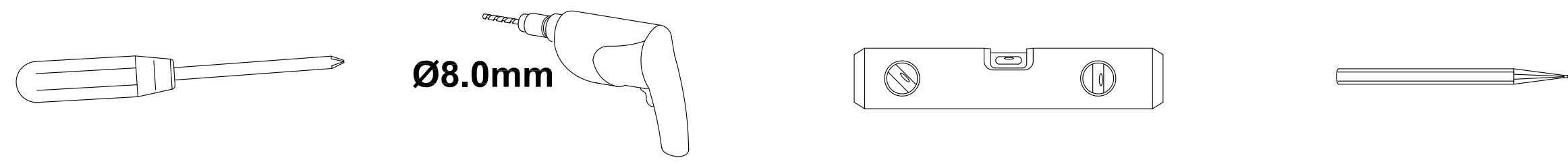

Width 300mm
Depth 180mm
Height 803mm

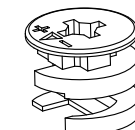
- **White units have protective film on the front and side panels, please remove this film after installation.**

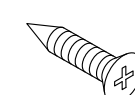
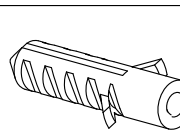
TOOLS REQUIRED:

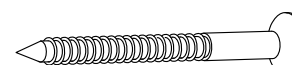

CODE	SIZE (mm)	QTY	CODE	DIAGRAM	QTY
A	263 x 144 x 18	1	G		12
B	144 x 54 x 18 (LH)	1	H		8
C	144 x 54 x 18 (RH)	1	I		2
D	300 x 54 x 18	1	J		4
E	803 x 300 x 21	1	K		2
F		8	L		2

Step 1:

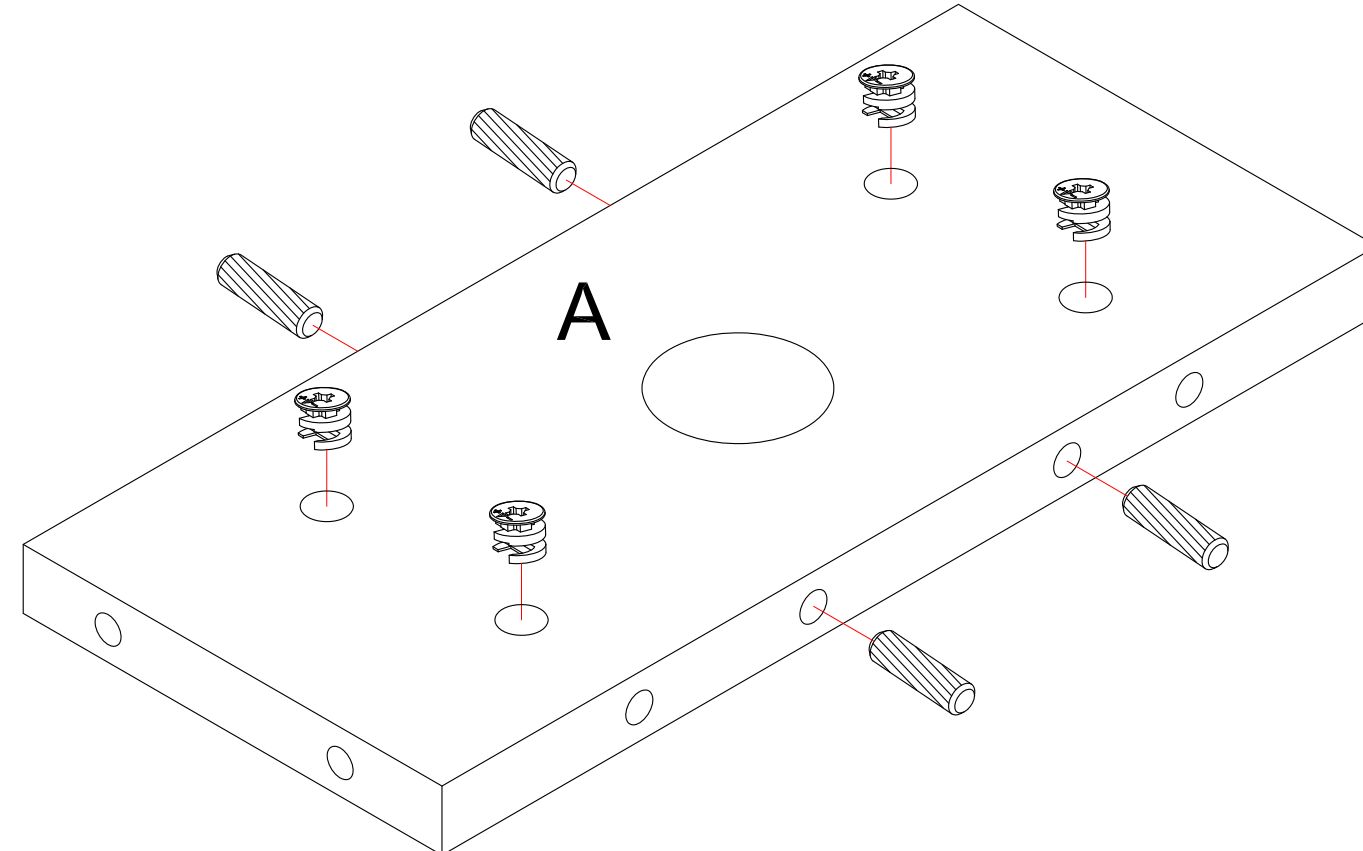
CODE	SIZE/DIAGRAM	QTY
A	263 x 144 x 18	x1
G		x4
H		x4

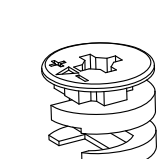

Step 2:

CODE	SIZE/DIAGRAM	QTY
B	144 x 54 x 18	x1
C	144 x 54 x 18	x1
G		x4
H		x4

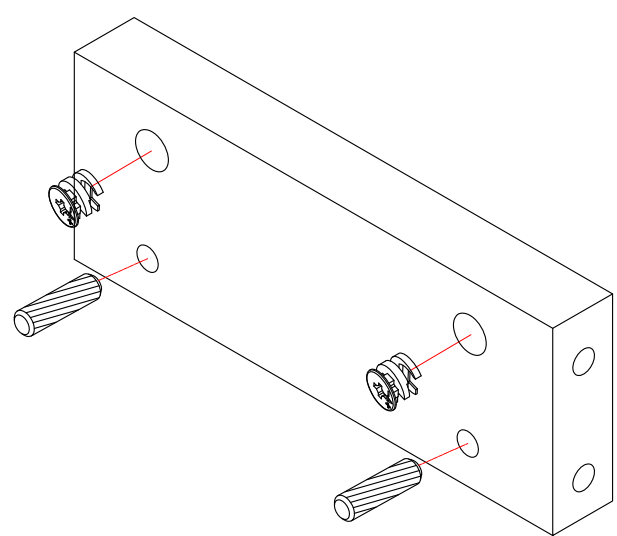

Step 3:

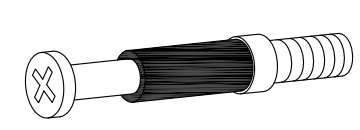
CODE	SIZE/DIAGRAM	QTY
D	300 x 54 x 18	x1
F		x4

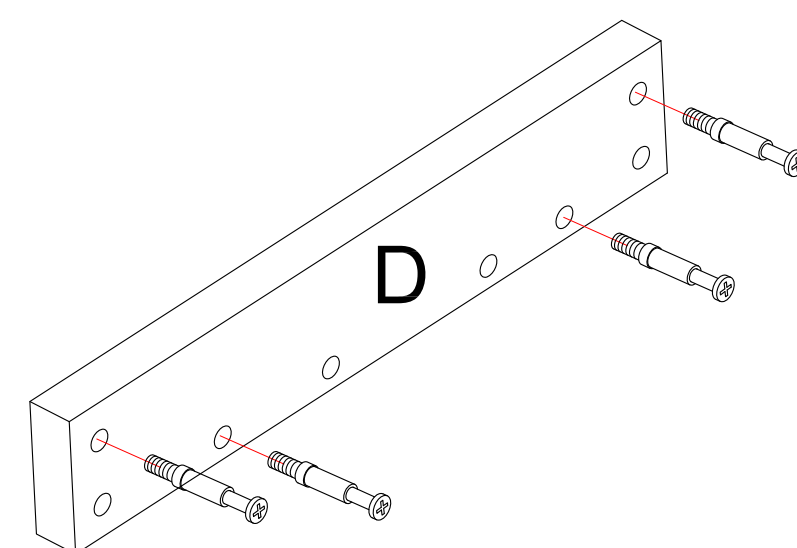

Step 4:

CODE	SIZE/DIAGRAM	QTY
G		x4

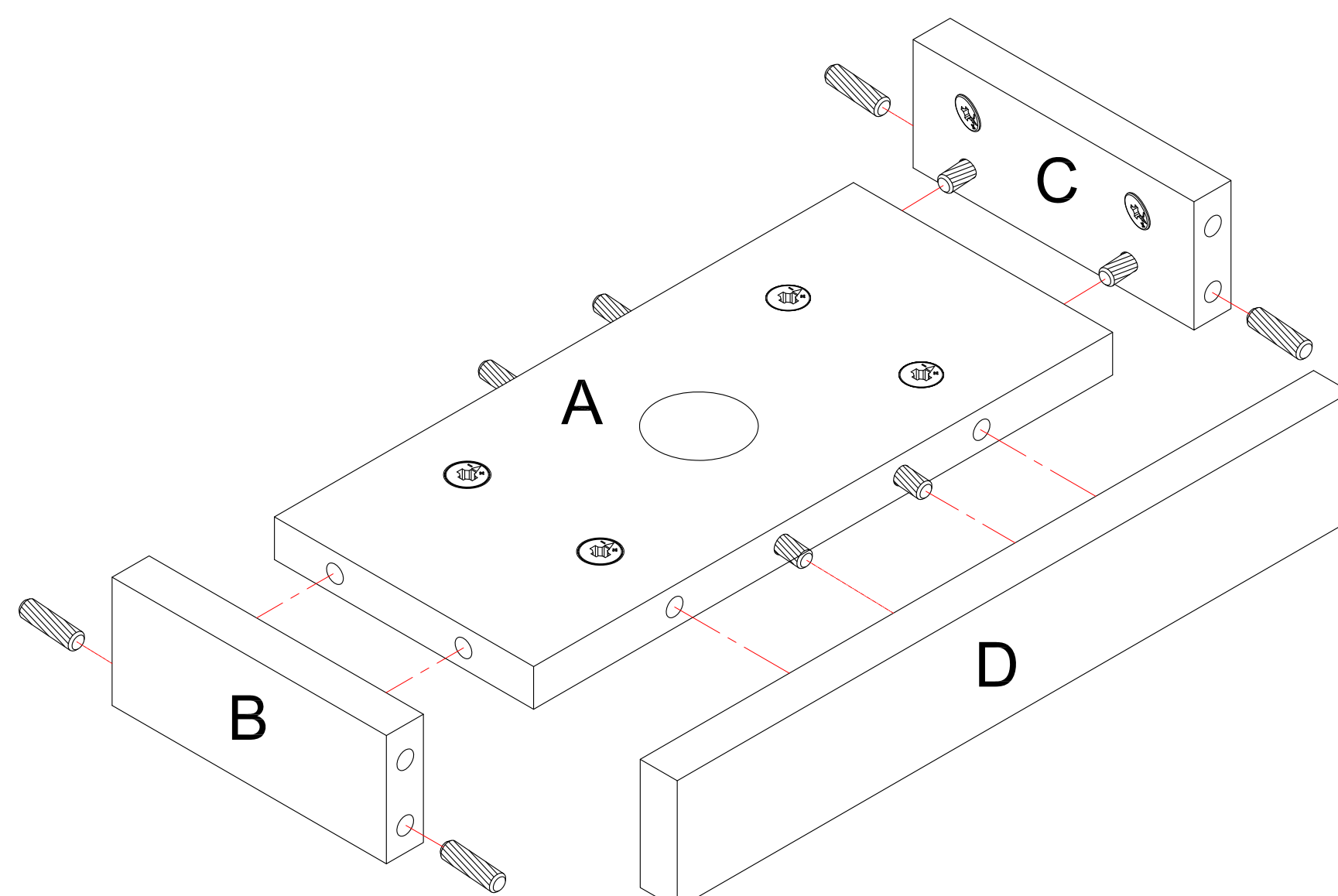

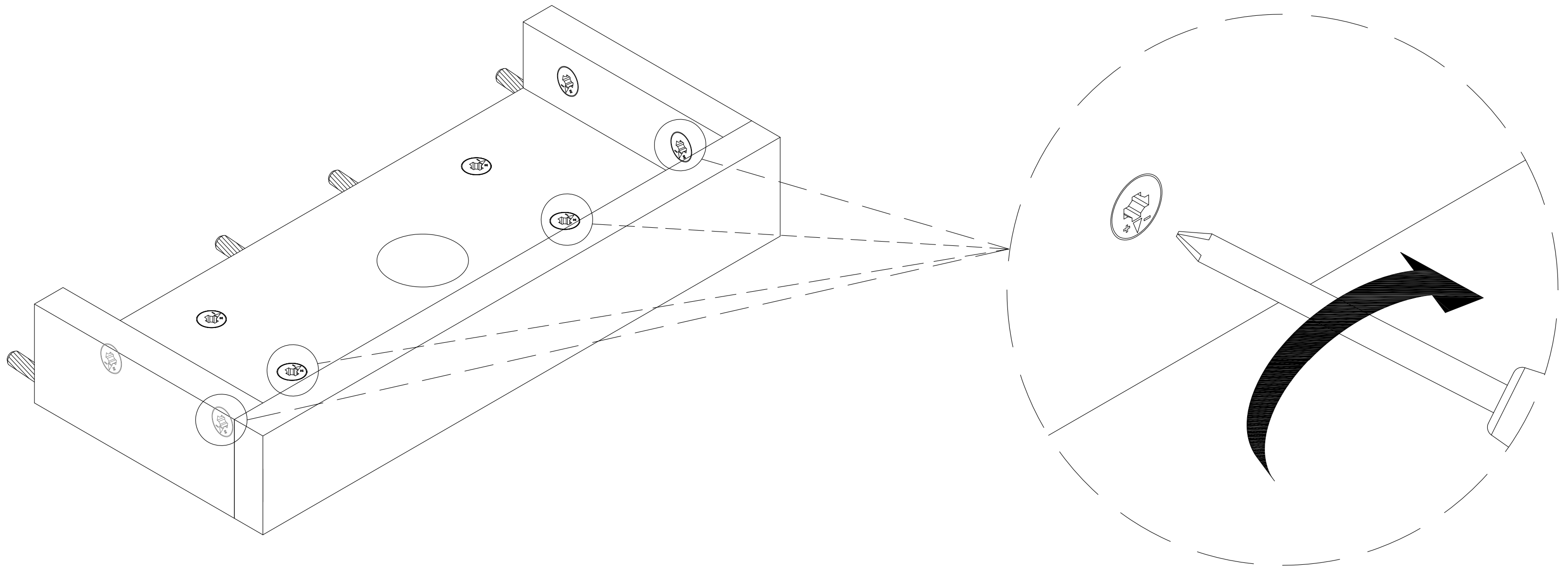

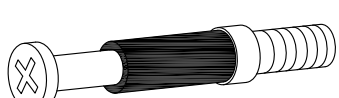
Step 5:

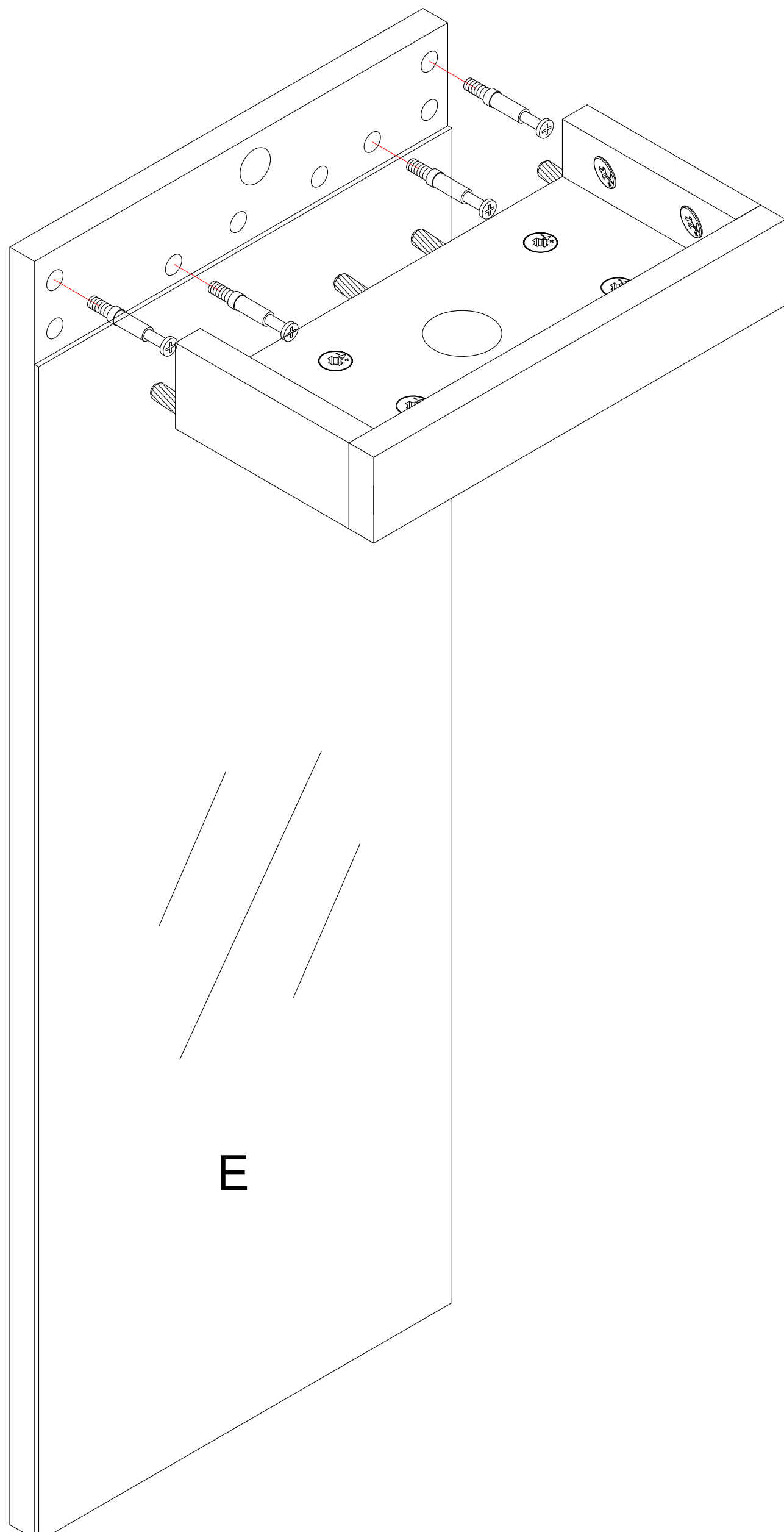
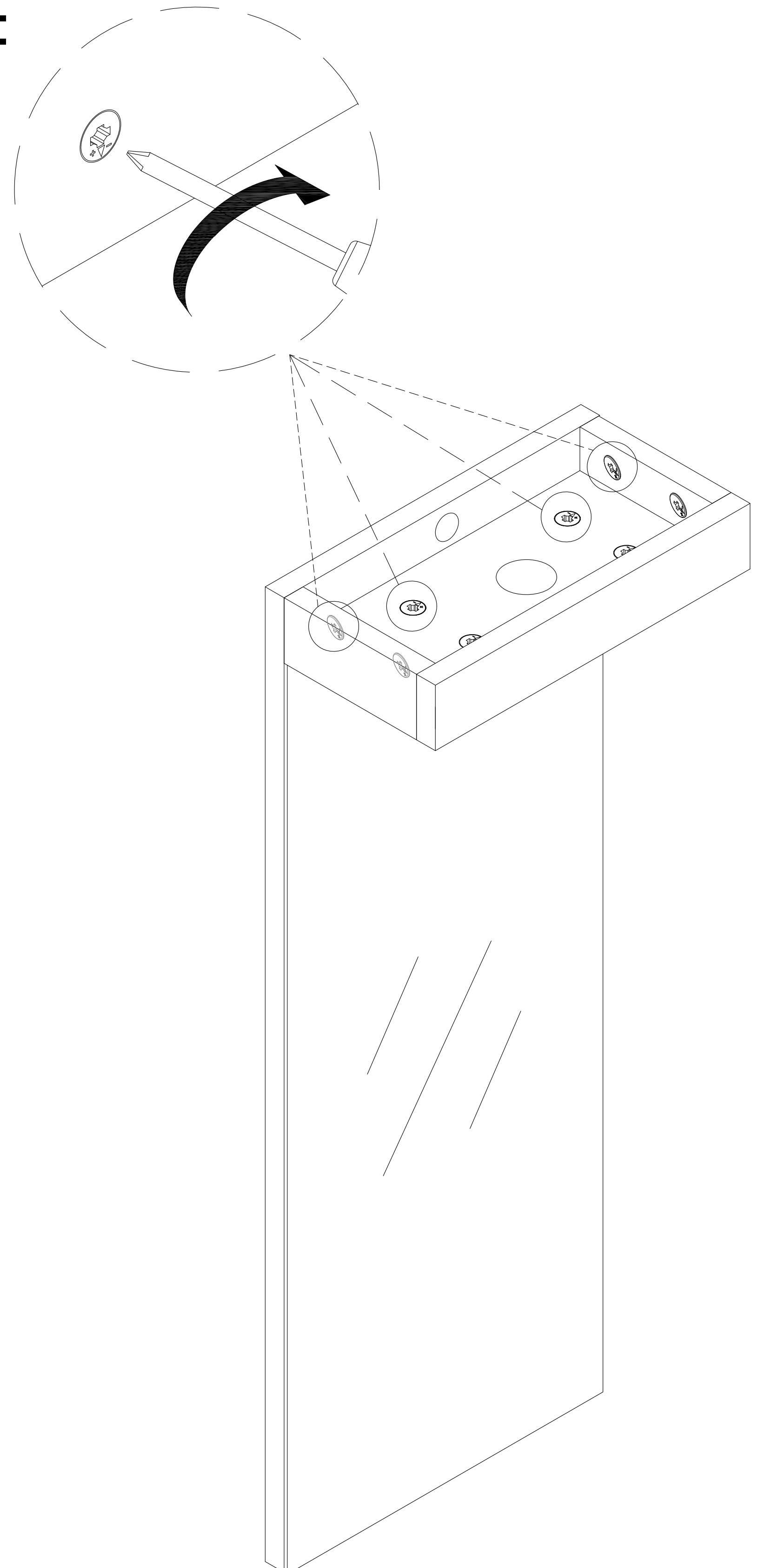
Step 6:

CODE	SIZE/DIAGRAM	QTY
E	803 x 300 x 21	x1
F		x4

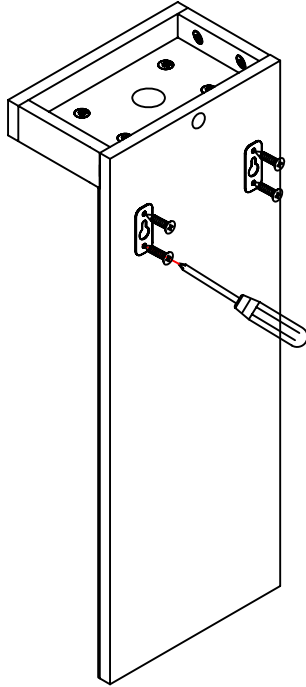

Step 7:

Step 8:

CODE	SIZE/DIAGRAM	QTY
I		x2
J		x4



Step 9:

CODE	SIZE/DIAGRAM	QTY
K		x2
L		x2

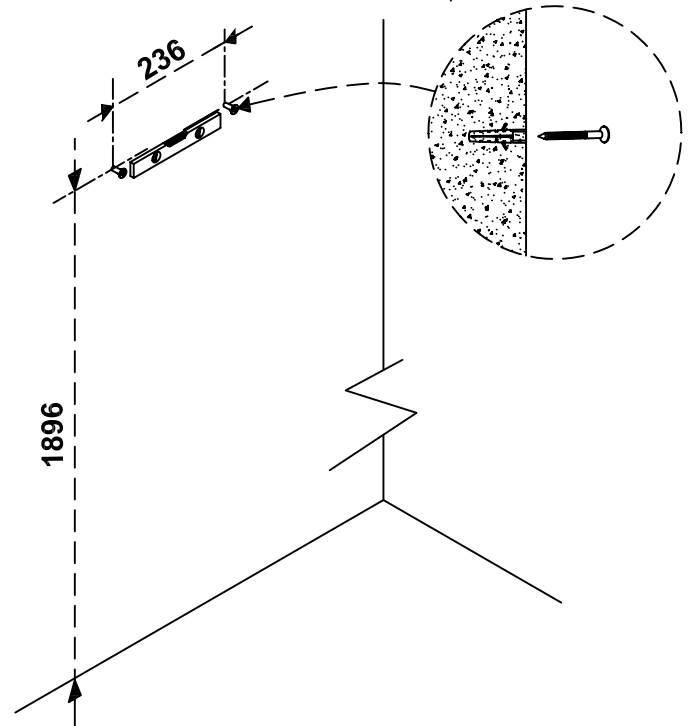

Step 10:

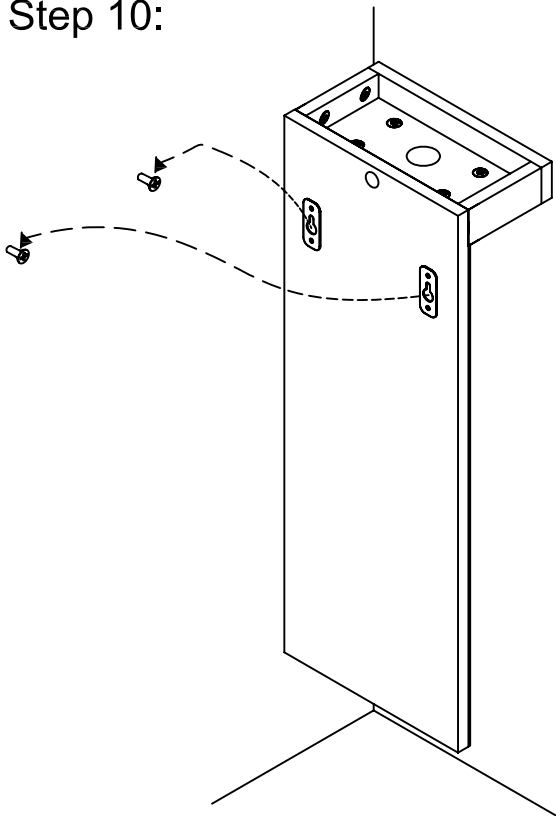

Step 11:

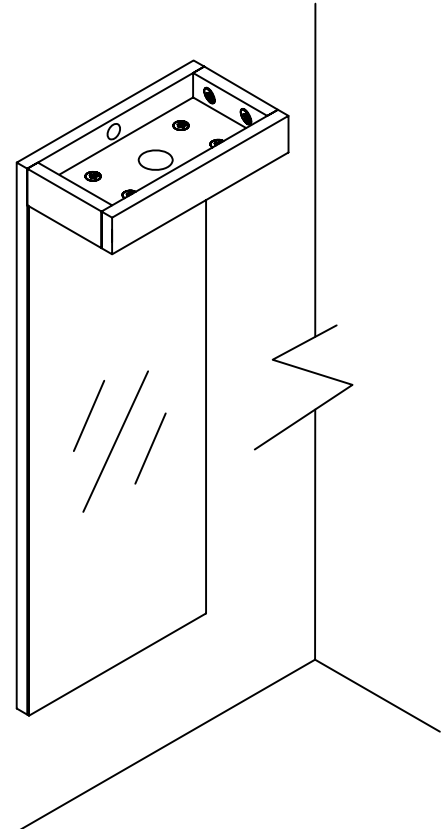

Care and Maintenance

Please leave with the householder

This furniture is made of wood, and has a water resistant finish. It should not be left wet. The quality of the finish is best maintained if it is wiped with a dry cloth after use. It should only be cleaned using a soft damp cloth followed by a dry cloth. Do not use bleach or any abrasive cleaner.

BATHSTORE MyRoom™ & OpenSpace™ HALOGEN DOWNLIGHT PACK FOR ILLUMINATED MIRROR

INSTALLATION INSTRUCTIONS

The illuminated mirror is intended to be installed in a bathroom or shower-room. It should be wall-mounted outside of Zones 0, 1 or 2 (see Fig below) to avoid risk of water ingress.

Electrical installation:

The mirror is supplied complete with the following electrical components:-

1 x 230-240V~ transformer with 12V Safety Extra Low Voltage (SELV) output, complete with supply cables.

2 x SELV 12V 20W recessed halogen lamp fittings, complete with connectors.

1 x bag of fixing screws.

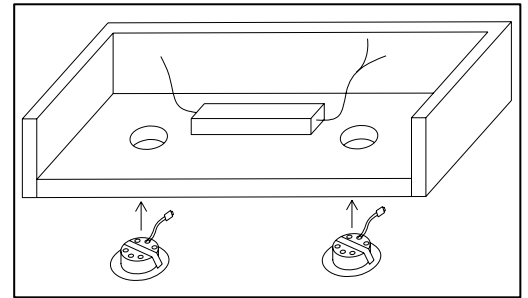

Installing the electrical components: The two recessed lamp fittings should be installed into the holes in the mirror canopy.

The transformer should be fixed within the mirror canopy close to the lamps (but not touching them), for ease of connection. Connect the two output wire connections to the lamp connectors.

Connection to the electricity supply: It should be connected to the household fixed wiring by a qualified electrician in accordance with the national Wiring Regulations (BS.7671). It can either be connected to the same lighting circuit as existing bathroom lighting, controlled by the same switch, or it can be connected independently to the general lighting circuit by installing its own cord-pull switch (not supplied). The transformer is Class II and does not require earthing. The supply cable is 2 x 0.75mm².

Lamp replacement: The fitted lamps are 12V 20W G4 type halogen lamps. Always replace with the same type and rating. Do not exceed the 20W rating. To change the lamp firstly disconnect the electricity supply. Use a small flat-blade screwdriver to lever out the opaque lens cover. Gently pull out the failed lamp and insert the new one. Snap the lens cover back into position, and re-connect the electricity supply.

